

MEMS 1×N Optical Switch



1. PRODUCT OVERVIEW

OSW-1×N optical switch (Hereinafter referred to as MEMS optical switch), a multi-channel optical path switch modularization product which is researched by CORERAY. MEMS optical switch based on electrostatic driving and vertical micro technology is presented. Due to its advantages such as small in size, quickly and stable performance, it is mainly used in optical communication and test system. The optical path schemes as follows:

2. TYPICAL APPLICATIONS

- Multi-optical channel monitoring in optical transmission system
- LAN multi optical source/ detector auto switch, optical sensing multi-point dynamic monitoring system
- It is mainly used for Optical fiber, optical device, network and open country project automatic system test
- Installation and debugging of optical device

3. FEATURES

- Frequency switching speed
- Proven MEMS durability and reliability
- Small and exquisite volume
- TTL Control interface
- Modularize design
- Low Insertion Loss

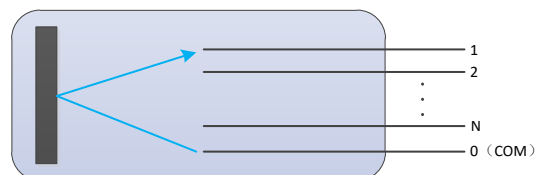

Optical Path Schematic

4. MAIN SPECIFICATIONS

PARAMETER	VALUE
Number of path	1~256
Working wave length (nm)	689
Fiber type (um)	PM
Insertion Loss (dB)	1.5
Return Loss (dB)	≥50
Crosstalk (dB)	>60
Repeatability (dB)	≤±0.02
Switch Time (ms)	≤5
Switch lifetime (time)	≥10 ⁹
Optical power (mW)	500
Operation Temperature (°C)	-20~+70
Storage Temperature (°C)	-40~+80
Control interface	TTL、UART (RS232)
Control Voltage (V)	5V
Dimension (mm)	90*55*12

5. Overall Dimensions

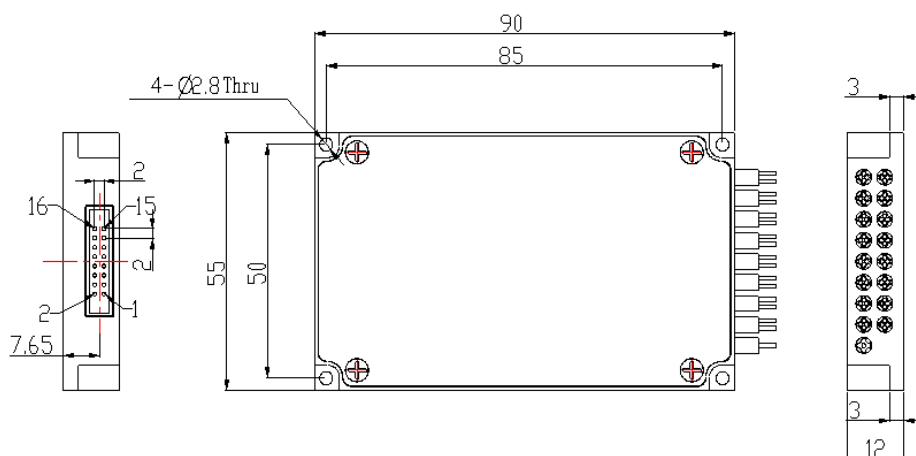

6. PIN DEFINITION

PIN NUMBER		PIN NAME	FUNCTION	LEV	NOTE
M3,4,5	M1,2				
1	5	D0	IN	LVTTTL	TTL mode: data bit D0 input
2	/	D5	IN	LVTTTL	TTL mode: data bit D5 input
3	2	VCC	Power IN	/	Positive DC +5V, Max Current
4	/	D7	IN	LVTTTL	TTL mode: data bit D7 input
5	/	D6	IN	LVTTTL	TTL mode: data bit D6 input
6	4	GND	Power IN		Power Ground
7	10	D4	IN	LVTTTL	TTL mode: data bit D4 input
8	12	D1	IN	LVTTTL	TTL mode: data bit D1 input
9	6	TXD	/	/	UART_TX
10	7	RXD	/	/	UART_RX
11	9	D2	IN	LVTTTL	TTL mode: data bit D2 input
12	13	D3	IN	LVTTTL	TTL mode: data bit D3 input
13	8	/BUSY	OUT	LVTTTL	
14	1	/ALARM	OUT	LVTTTL	
15	3	/STROBE	IN	LVTTTL	TTL mode: falling edge effective
16	14	/RESET	IN	LVTTTL	Reset, low level effective, pulse width>10ms

7. ORDERING INFORMATION

N	A	B	C	D	E	F
Port	Mode	Wavelength	Fiber Diameter	Fiber Length	Connector	Interface
2	SM:9/125um	85:850nm	25:250um	05:0.5m	OO:None	M1 :PCB
4	M5:50/125um	13: 1310nm	90:900um	10:1.0m	FP: FC/PC	M2:39*24*13.5
8	M6:62.5/125um	14: 1490nm		12:1.2m	FA: FC/APC	M3:90*55*12
.	M10:105/125um	15: 1550nm			SP: SC/PC	M4:100*100*12
.	PMXXXX:PM				SA: SC/APC	M5:110*141*12
.	Fiber				LP: LC/PC	
256					LA: LC/APC	
					MPO	